





Beam Pro 1-P

IP20    

Kohdevalaisin 1-vaihekiskoihin | Spotlight för 1-fasskenor | Spotlight for 1-circuit tracks

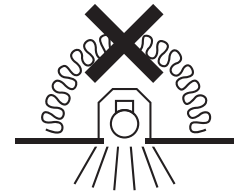
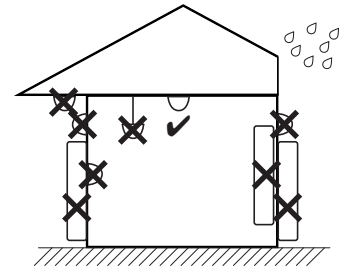
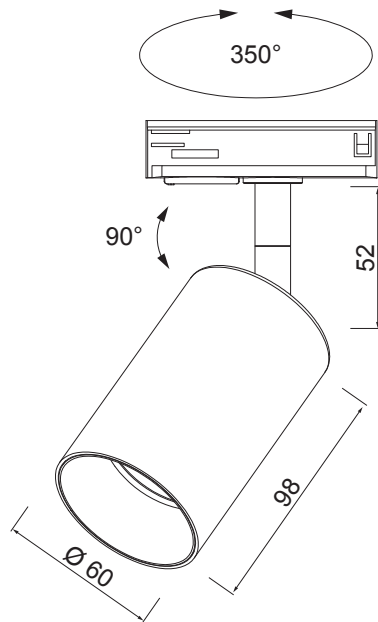

Valaisinta ei saa asentaa suoraan eristemateriaaliin.

Denna armatur är inte avsedd för att täckas med värmeisolerande material.

The luminaire is not suitable for covering with thermally insulated material.



LED GU10 PAR16 max 7W

Led-lamppu ei sisälly pakkaukseen.
Led ljuskälla medföljer ej.
Lamp not included.

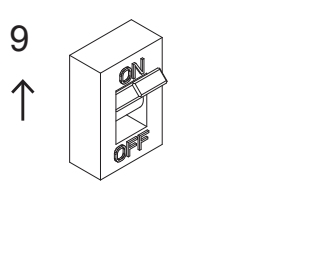
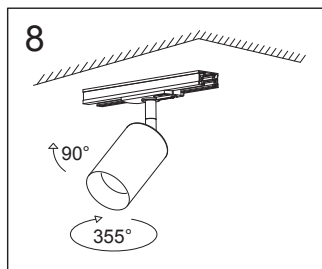
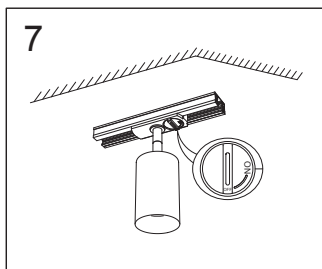
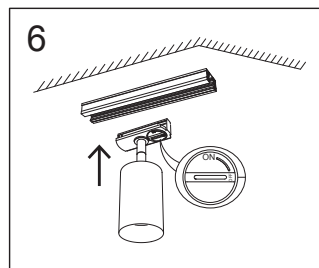
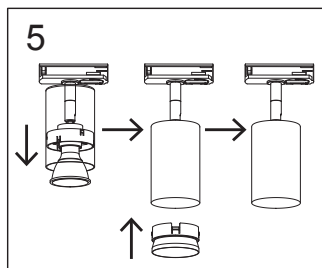
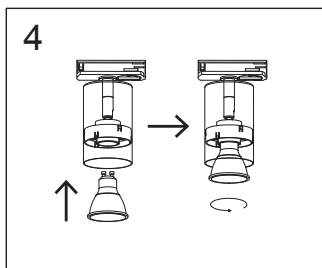
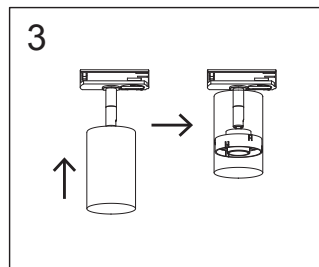
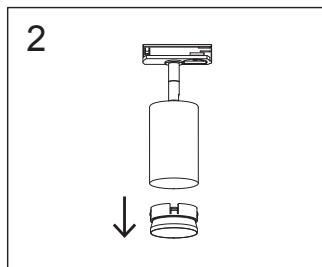
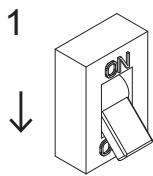

FI

Valaisimen saa asentaa vain sähköalan ammattilainen. Käytä ainoastaan syöttöjännitettä ja taajuutta joka on merkitty valaisimeen/liitäntälaitteeseen. Kytke virta pois päältä ennen asennusta tai huoltoa. Tämä asennusohje on säilytettävä ja sen on oltava käytössä asennuksessa ja huollossa.

SE

Vi rekommenderar att installationen görs av en behörig elektriker. Använd endast driftspänning och frekvens som är märkt på armaturen/förkopplingsdonet. Bryt av strömmen för installation eller service. Denna monteringsanvisning bör sparas och finnas tillgänglig vid installation eller framtida service.

EN

Only a professional electrician is allowed to do the installation. Use only rated voltage and frequency as marked in the fixture/driver. Switch off the current before installation or service. This mounting instruction must be kept available during installation and for future maintenance.

Beam Pro 3-P

IP20    

Kohdevalaisin 3-vaihekiskoihin | Spotlight för 3-fasskenor | Spotlight for 3-circuit tracks

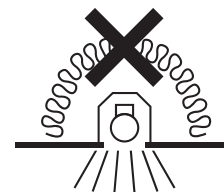
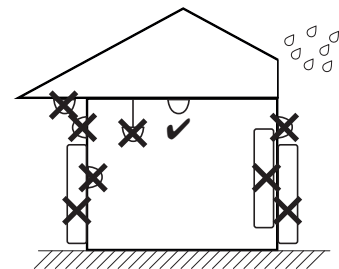
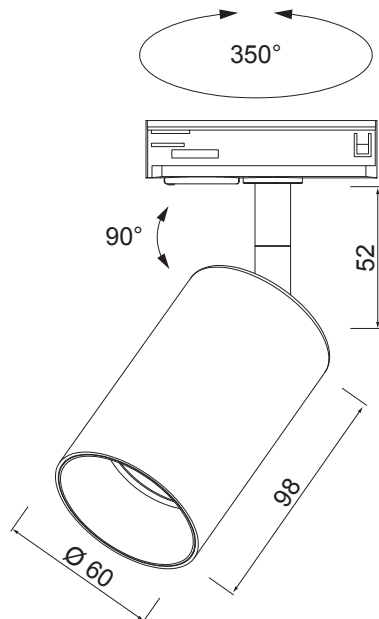

Valaisinta ei saa asentaa suoraan eristemateriaaliin.

Denna armatur är inte avsedd för att täckas med värmeisolerande material.

The luminaire is not suitable for covering with thermally insulated material.

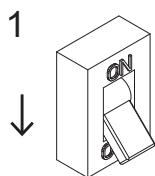

LED GU10 PAR16 max 7W

Led-lamppu ei sisälly pakkaukseen.
Led ljuskälla medföljer ej.
Lamp not included.

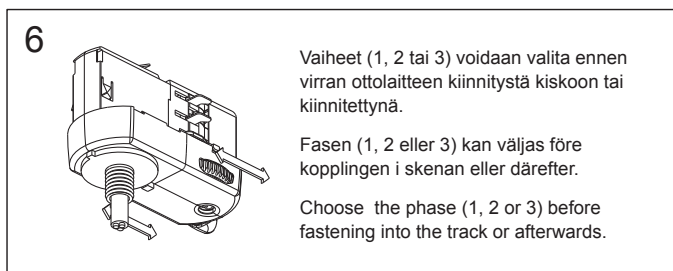
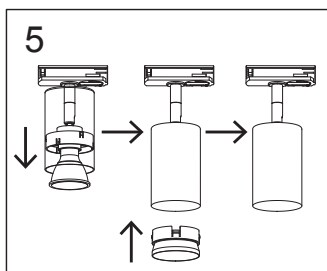
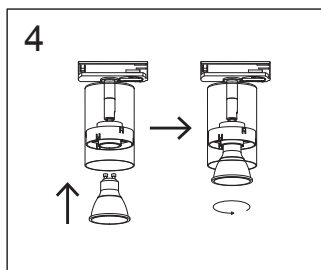
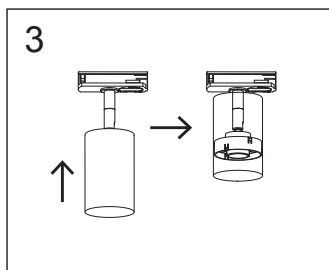
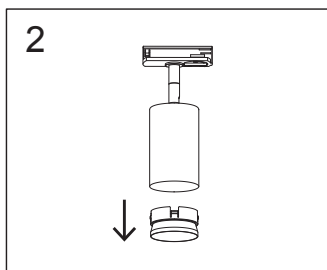

Vaiheet (1, 2 tai 3) voidaan valita ennen virran ottolaitteen kiinnitystä kiskoon tai kiinnitettynä.

Fasen (1, 2 eller 3) kan väljas före kopplingen i skenan eller därefter.

Choose the phase (1, 2 or 3) before fastening into the track or afterwards.

SE

Vi rekommenderar att installationen görs av en behörig elektriker. Använd endast driftspänning och frekvens som är märkt på armaturen/förkopplingsdonet. Bryt av strömmen för installation eller service. Denna monteringsanvisning bör sparas och finnas tillgänglig vid installation eller framtida service.

EN

Only a professional electrician is allowed to do the installation. Use only rated voltage and frequency as marked in the fixture/driver. Switch off the current before installation or service. This mounting instruction must be kept available during installation and for future maintenance.

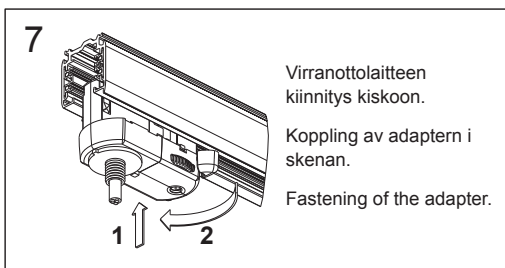

Virranottolaitteen kiinnitys kiskoon.

Koppling av adaptern i skenan.

Fastening of the adapter.

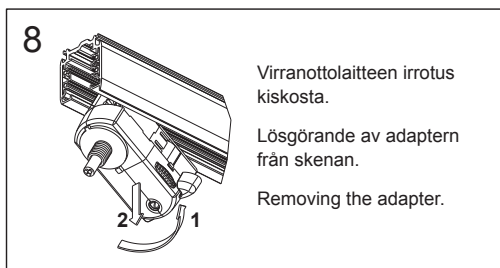

Virranottolaitteen irrotus kiskosta.

Lösgörande av adaptern från skenan.

Removing the adapter.

