

# Artemide®

## Tolomeo Micro

design  
M. De Lucchi  
G. Fassina

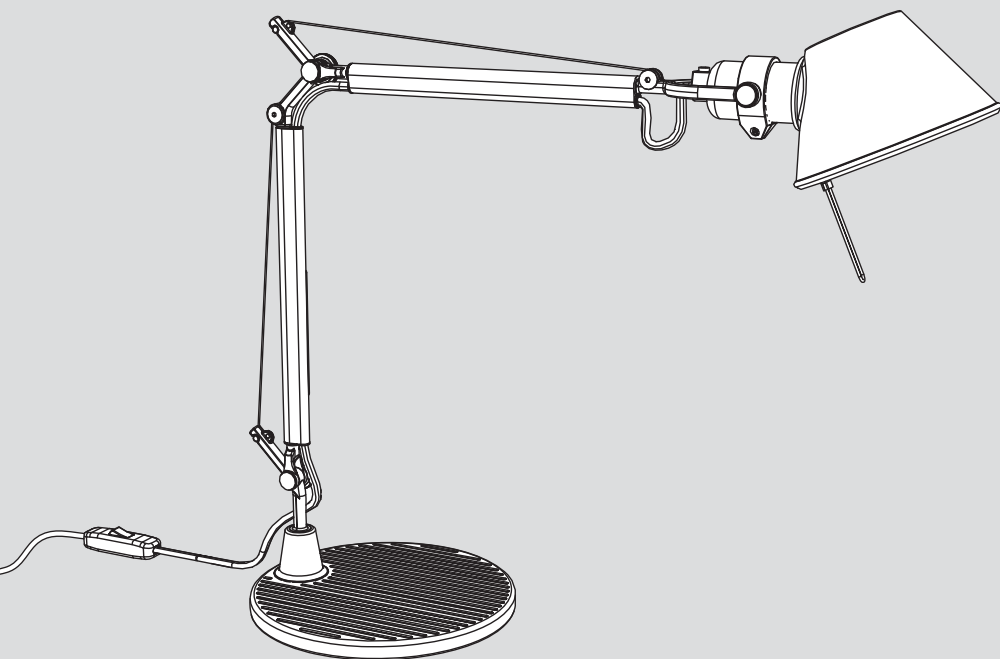



i

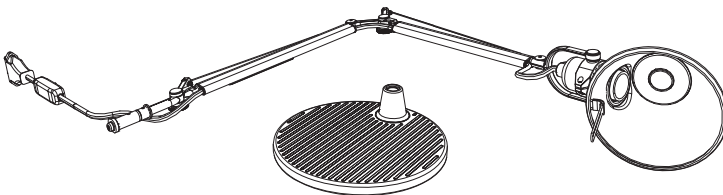
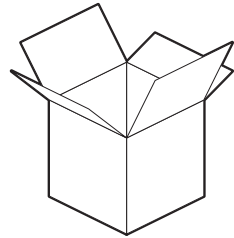
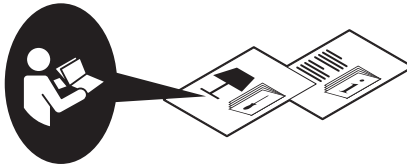
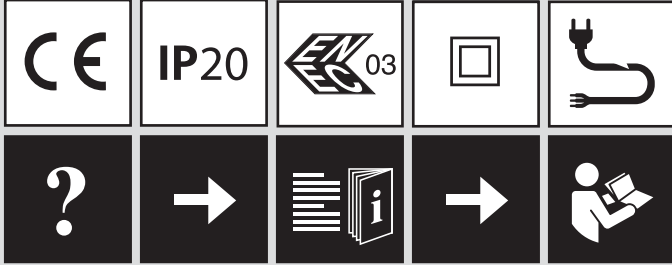

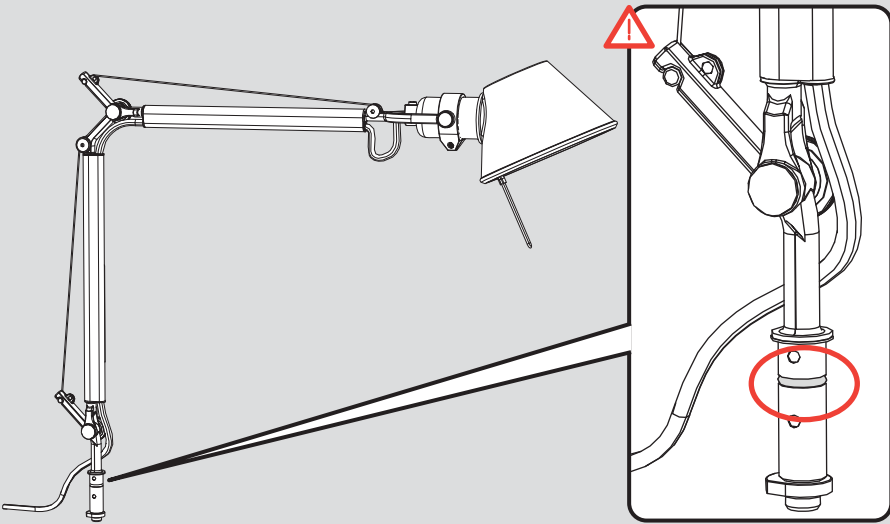

1

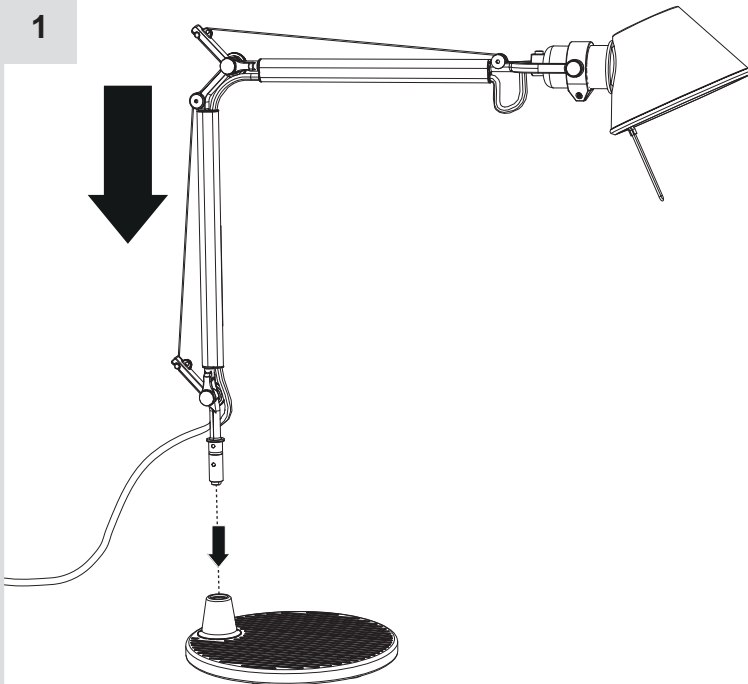

2

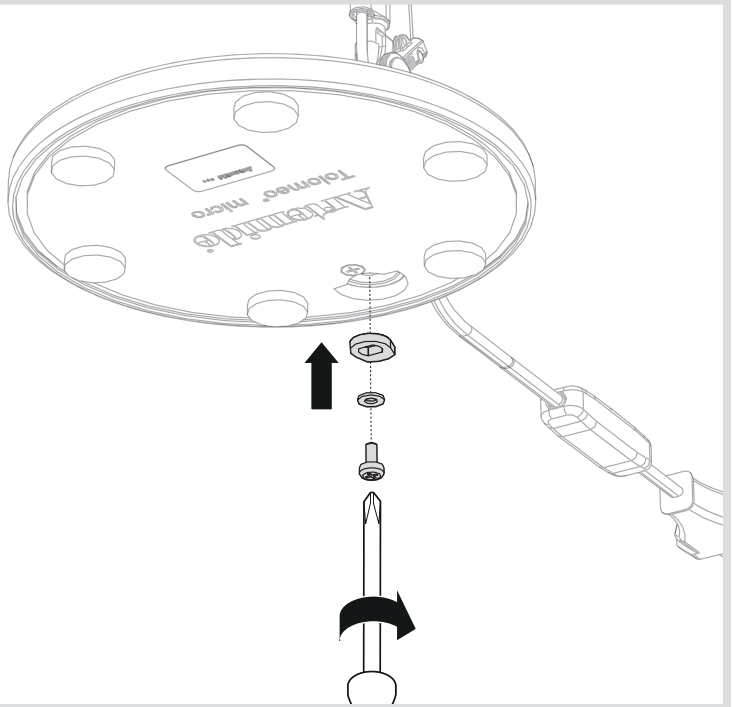

3

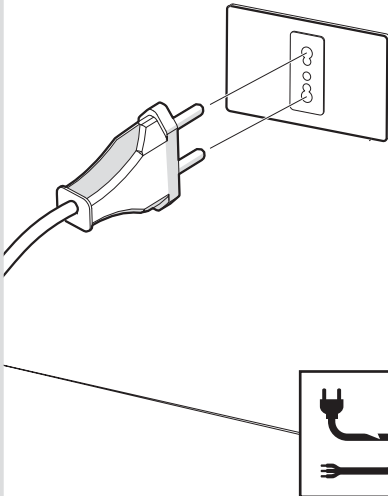

4

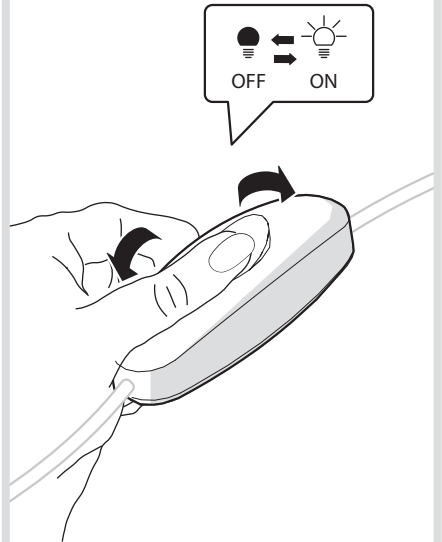

i

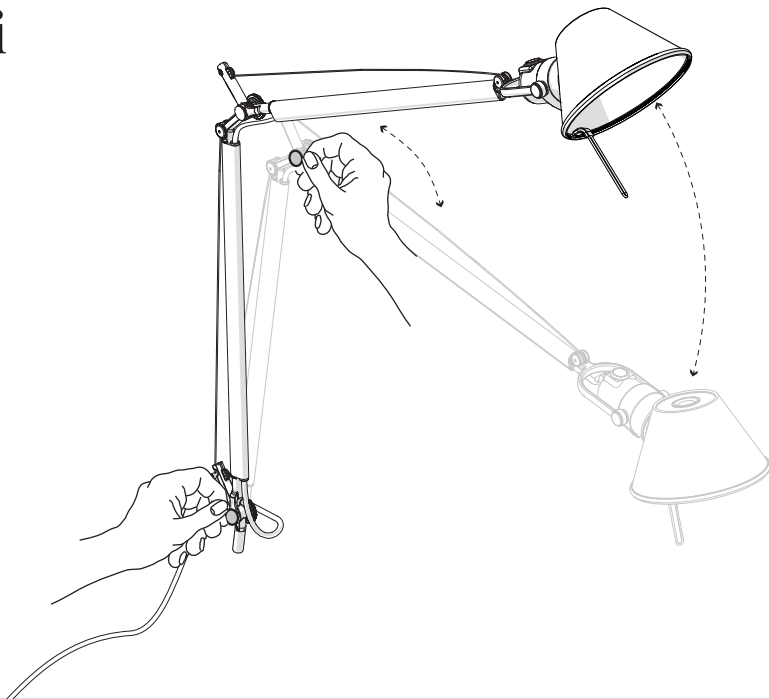

i

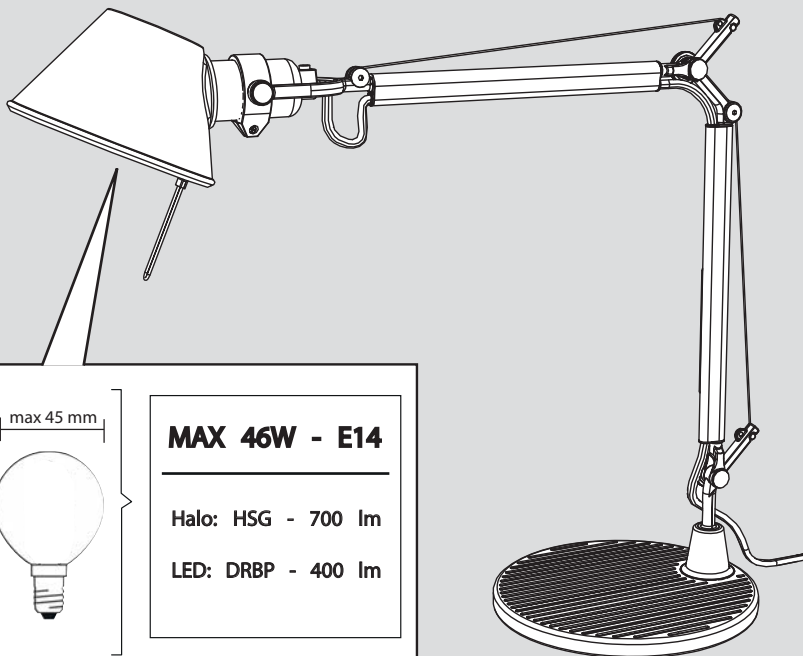

max 45 mm

max 77 mm



**MAX 46W - E14**

Halo: HSG - 700 lm

LED: DRBP - 400 lm

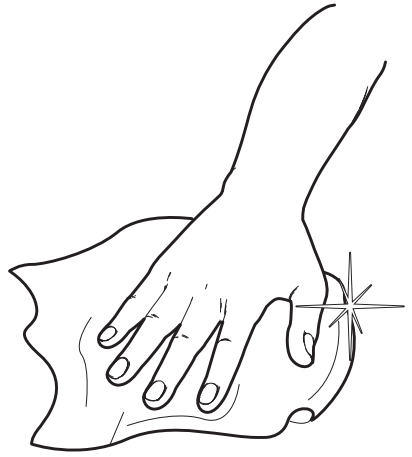
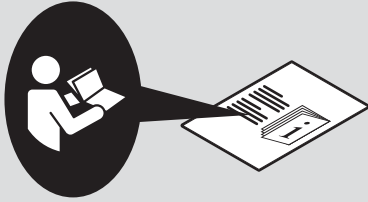



**Artemide®**



**Artemide**

via Bergamo, 18  
20010 Pregnana M.se (MI)  
ITALIA

tel. +39 02 935 181  
fax +39 02 935 90 254  
fax +39 02 935 90 496

[www.artemide.com](http://www.artemide.com)

VAT IT00846890150

cod. Y513000596