



modello:
model:

MATITA

codice:
code:

6703

design:

Mati

anno - year:

2021

tipologia:

lampada orientabile da incasso

typology:

adjustable recessed lamp

materiali:

**corpo in estruso di alluminio,
diffusore in policarbonato opale**

materials:

**extruded aluminum structure, opal
polycarbonate diffuser**

luce:

diretta/diffusa

light:

direct/diffuse

sorgente luminosa:

/W LED 9W 1036lm 4000K CRI>90

light source:

/WW LED 9W 945lm 3000K CRI>90

/XW LED 9W 840lm 2700K CRI>90

grado IP - IP grade:

20

peso netto:

0,40 Kg

net weight:

finiture - finishes:

.02 nero

.02 black

marcatura:

CE

marking:

simboli costruttivi:

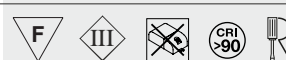

symbols:

Dimensioni - Dimensions

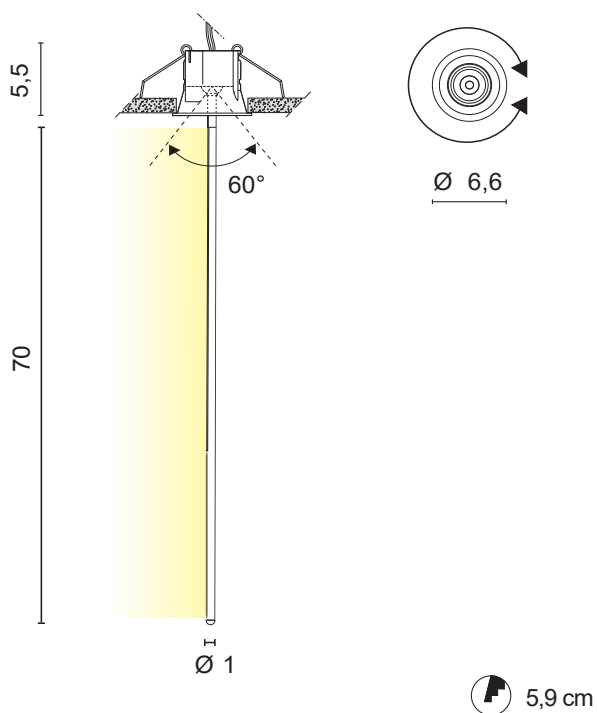

La presente scheda tecnica è di proprietà di EGOLUCE srl. Tutti i diritti sono riservati. Le fotografie, le descrizioni degli apparecchi, disegni quotati ed i valori fotometrici menzionati sono a titolo indicativo e non costituiscono alcun impegno per la nostra società che si riserva di apportare, in qualsiasi momento e senza preavviso, tutte le modifiche che riterrà opportune.

EGOLUCE s.r.l., via I.Newton 12 - 20016 Pero - Milano
telefono +39 02 339586.1 - fax. +39 02 3535112
e-mail: info@egoluce.com - http://www.egoluce.com

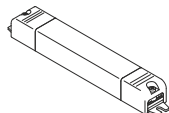
Codice
Articolo**DRIVERS a tensione costante**
DRIVERS constant voltage**0155****LED driver**
IN: 100 - 240V
OUT: 24V - 13W

15,8 x 2,2 x 2 cm 3,2 cm

SELV

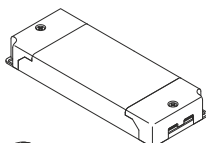
0156**LED driver**
IN: 100 - 240V
OUT: 24V - 25W

14,5 x 5,5 x 2 cm 6 cm

SELV

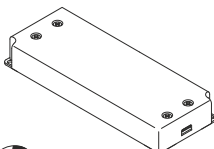
0157**LED driver**
IN: 220 - 240V
OUT: 24V - 75W

18,4 x 6,1 x 2,9 cm 7 cm

SELV

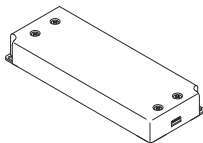
0160**LED driver**
IN: 220 - 240V
OUT: 24V - 50W

16,7 x 6 x 2,9 cm 7 cm

SELV

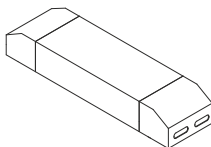
0161/100**LED driver**
IN: 220 - 240V
OUT: 24V - 100W

21 x 7,5 x 3,5 cm 8 cm

SELV

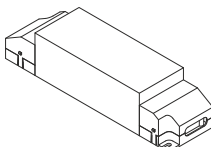
0162**LED driver**
IN: 220 - 240V
OUT: 24V - 150W

24 x 6 x 5 cm 8 cm

SELV

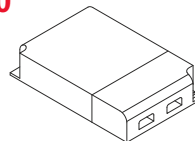
DRIVERS DIMMERABILI a tensione costante
DIMMABLE LED DRIVERS constant voltage**0717/DIM60****LED dimmer**
IN: 220 - 240V
OUT: 24V - 60W

12,6 x 8,1 x 3 cm 8,6 cm

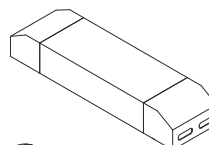
1...10 V SELV**0717/DIM100****LED dimmer**
IN: 220 - 240V
OUT: 24V - 100W

21 x 7,5 x 3,5 cm 8,2 cm

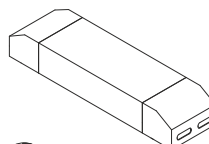
1...10 V SELV**0717/DIM150****LED dimmer**
IN: 220 - 240V
OUT: 24V - 150W

21 x 7,5 x 3,5 cm 8,2 cm

1...10 V SELV**0727/DIM****LED dimmer**TAGLIO DI FASE (TRIAC, TRAILING EDGE-LEADING EDGE)
PHASE CUT-OFF (TRIAC, TRAILING EDGE-LEADING EDGE)IN: 220 - 240V
OUT: 24V - 45W

8,2 cm

18 x 6 x 3,5 cm SELV

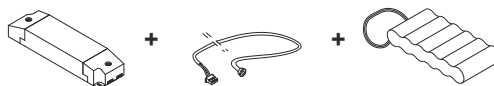
UNITÀ DI EMERGENZA LED
LED EMERGENCY UNIT**0115/EM****LED Emergency Unit**
Kit Inverter + Battery + LED indicator

15,5 x 5,2 x 2,5 cm 80 cm 13,5 x 4,5 x 2,3 cm



La presente scheda tecnica è di proprietà di EGOLUCE srl. Tutti i diritti sono riservati. Le fotografie, le descrizioni degli apparecchi, disegni quotati ed i valori fotometrici menzionati sono a titolo indicativo e non costituiscono alcun impegno per la nostra società che si riserva di apportare, in qualsiasi momento e senza preavviso, tutte le modifiche che riterrà opportune.

EGOLUCE s.r.l., via I.Newton 12 - 20016 Pero - Milano
telefono +39 02 339586.1 - fax. +39 02 3535112
e-mail: info@egoluce.com - http://www.egoluce.com