





modello: model:	ALCOR
codice: code:	6360
design:	UT Egoluce
anno - year:	2009
tipologia: typology:	faretto da incasso recessed spotlight
materiali: materials:	cristallo - alluminio crystal - aluminium
luce: light:	diffusa diffuse
sorgente luminosa: light sources:	/W LED 1W 350mA 158lm 4000K /WW LED 1W 350mA 150lm 3000K /XW LED 1W 350mA 143lm 2700K
life:	> 50.000 h
step MacAdam:	3
Indice di Resa Cromatica: Color Rendering Index:	>80
grado IP - IP grade:	44
peso netto - net weight:	0,03 Kg
finitura - finishing:	.50 cristallo .50 crystal
optional:	0212 kit: box + plaster traforato kit: box + perforated plaster 0215 controcassa in materiale plastico plastic box
marcatura: marking:	CE
simboli costruttivi: symbols:	F III IP44  

Dimensioni - Dimensions

**SOLO COLLEGAMENTO IN SERIE - ONLY SERIAL CONNECTION**

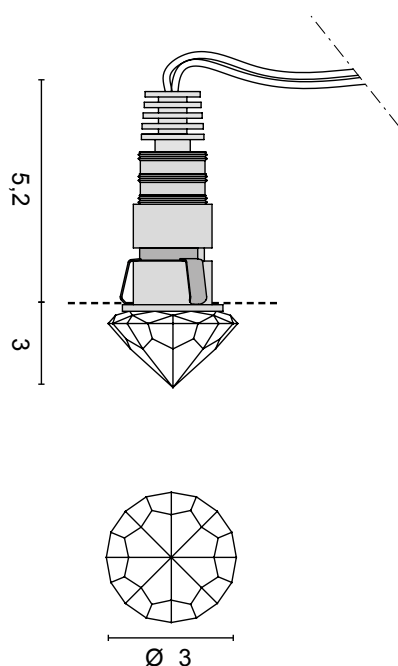
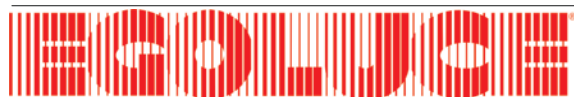
EGOLUCE s.r.l., via I.Newton 12 - 20016 Pero - Milano
 telefono +39 02 339586.1 - fax. +39 02 3535112
 e-mail: info@egoluce.com - http://www.egoluce.com

**0212**

KIT: box + Plaster

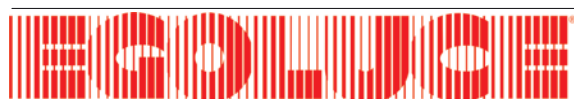
**0215**Controcassa in materiale plastico
Plastic box

EGOLUCE s.r.l., via I. Newton 12 - 20016 Pero - Milano
 telefono +39 02 339586.1 - fax. +39 02 3535112
 e-mail: info@egoluce.com - <http://www.egoluce.com>

La presente scheda tecnica è di proprietà di EGOLUCE srl. Tutti i diritti sono riservati. Le fotografie, le descrizioni degli apparecchi, i disegni quotati ed i valori fotometrici menzionati sono a titolo indicativo e non costituiscono alcun impegno per la nostra società che si riserva di apportare, in qualsiasi momento e senza preavviso, tutte le modifiche che riterrà opportune.

LED DRIVERS in corrente continua LED DRIVERS constant current

0125

LED driver
IN: 100 - 240V
OUT: 350 mA
1-6 Power LED



6 x 3,5 x 2,2 cm 4 cm

SELV

0128

LED driver
IN: 100 - 240V
OUT: 350 mA
1-10 Power LED

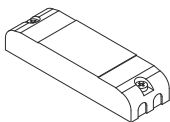

11,6 x 3,4 x 2 cm 4 cm

SELV CLASS 2

0136/15

LED driver
IN: 100 - 240V
OUT: 350 mA
1-10 Power LED

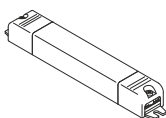

15,8 x 2,2 x 2 cm 3,2 cm

SELV

0169/50

Multipower LED driver

IN: 220 - 240V
OUT: 350mA

min. 4 - max 22 Power LED

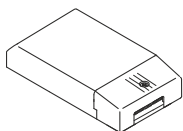

13 x 7,5 x 3 cm 8,5 cm

SELV

DRIVERS DIMMERABILI in corrente continua DIMMABLE LED DRIVERS constant current

0129 Dimmer LED

Multipower dimmable driver

IN: 110 - 240V
OUT: 350 mA
4-15 Power LED

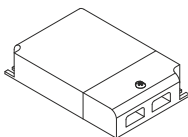

10,5 x 7 x 2,2 cm 7,2 cm SELV

0129/DALI Dimmer LED

Multipower dimmable driver

IN: 110 - 240V
OUT: 350 mA
2-12 Power LED

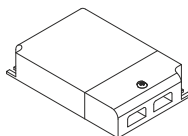

10,5 x 7 x 2,2 cm 7,2 cm SELV

0141/DALI

LED driver
IN: 110 - 240V
OUT: 350 mA
1-12 Power LED

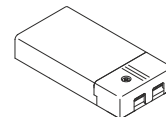

11,1 x 5,2 x 2,5 cm 5,5 cm

0141/DIM

LED driver
IN: 110 - 240V
OUT: 350 mA
1-12 Power LED

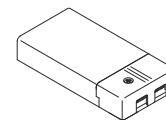

Versione PUSH non sincronizzabile - PUSH version not synchronizable

11,1 x 5,2 x 2,5 cm 5,5 cm

0145 Dimmer LED Maxi

Multipower dimmable driver

IN: 110 - 240V
OUT: 350 mA
1- 21 Power LED

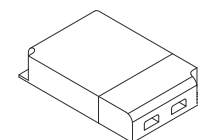

12,3 x 8 x 2,2 cm 8,4 cm SELV

0145/DALI Dimmer LED Maxi

Multipower dimmable driver

IN: 110 - 240V
OUT: 350 mA
1- 21 Power LED

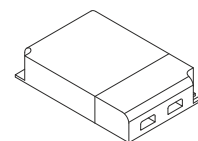

12,3 x 8 x 2,2 cm 8,4 cm SELV

0133

Cavo di sincronizzazione per dimmer LED
Synchronization cable for LED dimmer
(art. 0129 - art. 0129/DALI - art. 0145 - art. 0145/DALI)



L 150 cm

